

Du må tre alle nålene.

TRE

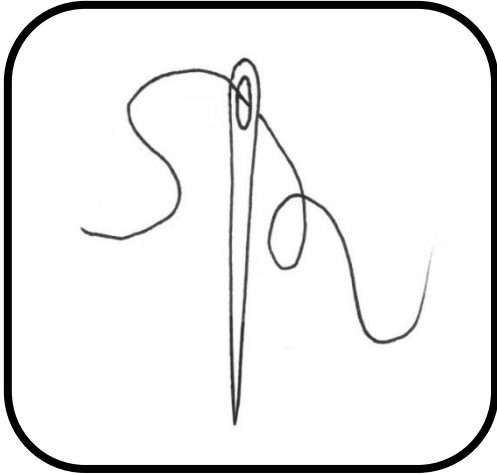

SpireGro

Jeg har dramatisert eventyret
om de tre bukkene Bruse.

TRE

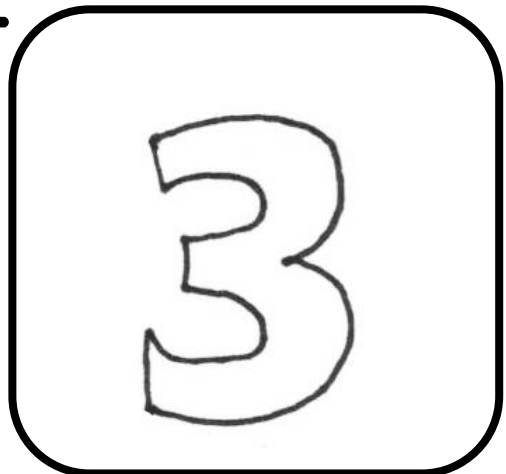
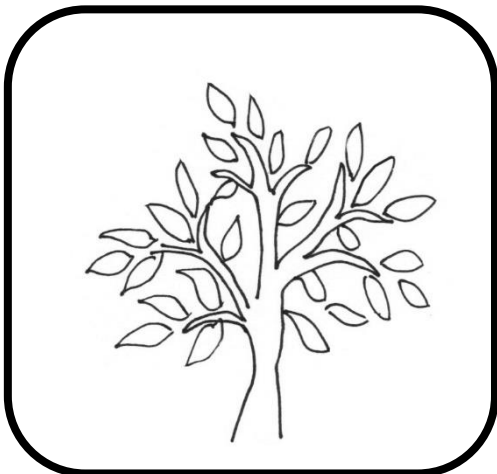

SpireGro

Stolene på skolen er laget av tre.

TRE

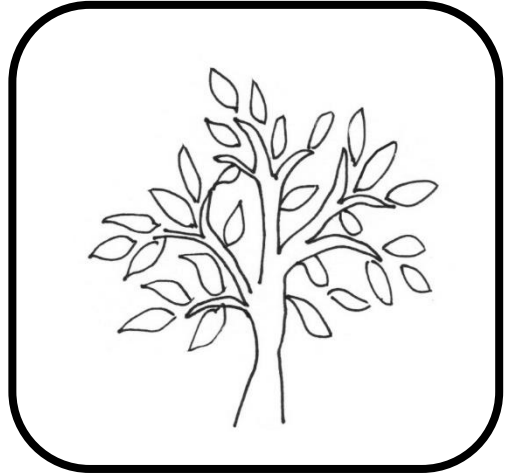

SpireGro

Musikeren hadde en svært kostbar bue.

BUE

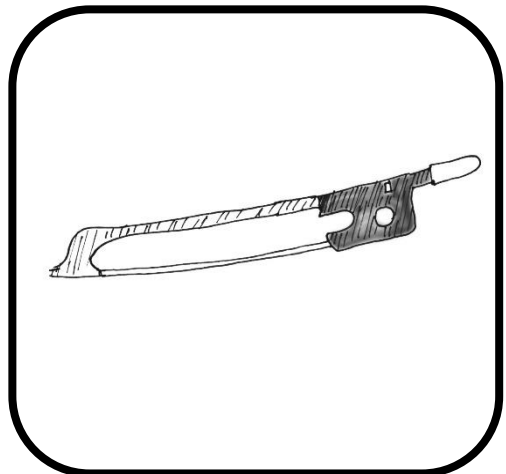
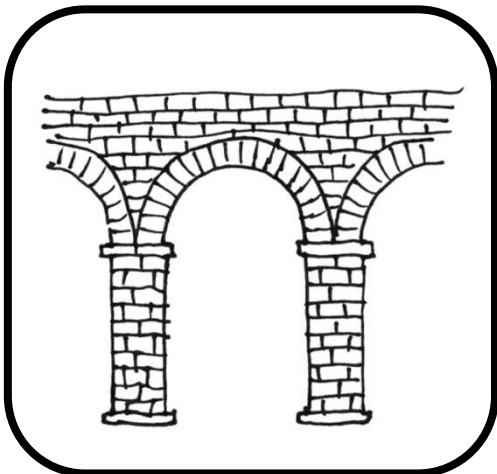

SpireGro

Ridderne passet godt på buene sine.

BUE

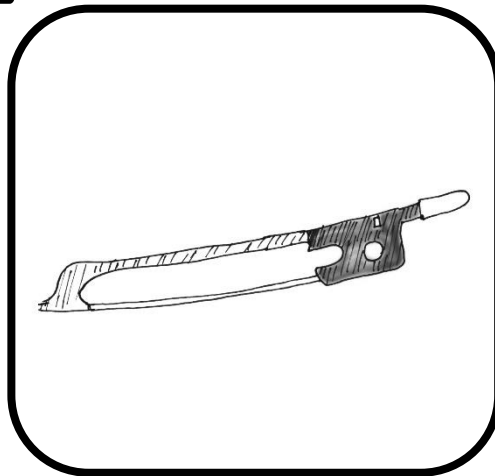
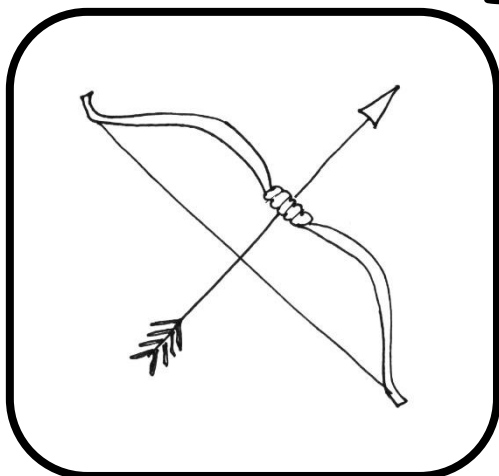

SpireGro

På togstasjonen var det en bue.

BUE

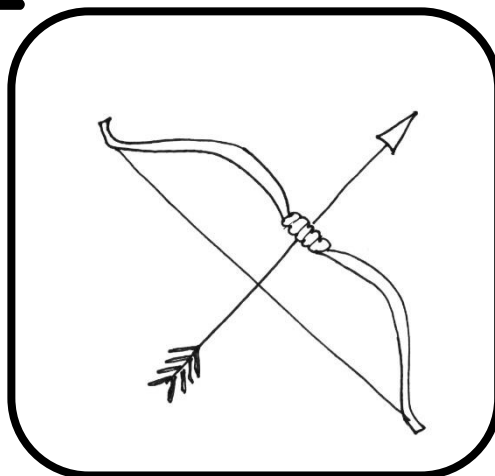
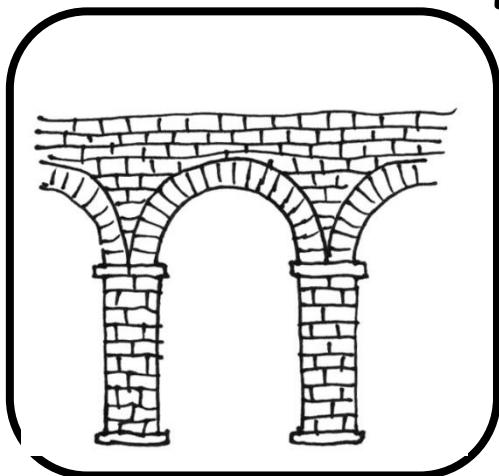

SpireGro

Hvis du glemte sitteunderlaget kan du bruke bar i stedet.

BAR

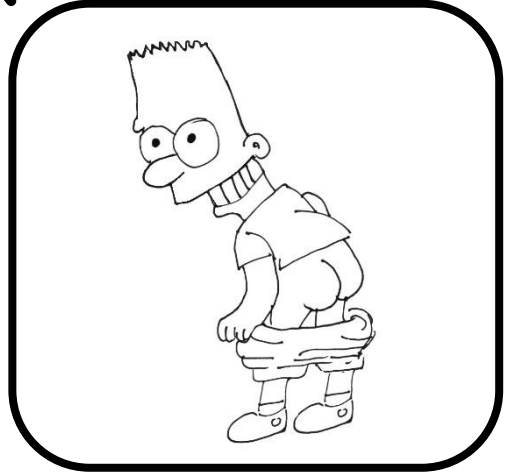

SpireGro

Det er kaldt å være bar.

BAR



SpireGro

Nissen fikk grøten sin servert i en bolle.

BOLLE

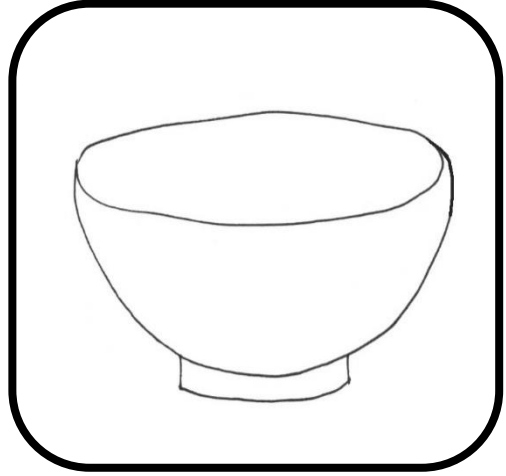
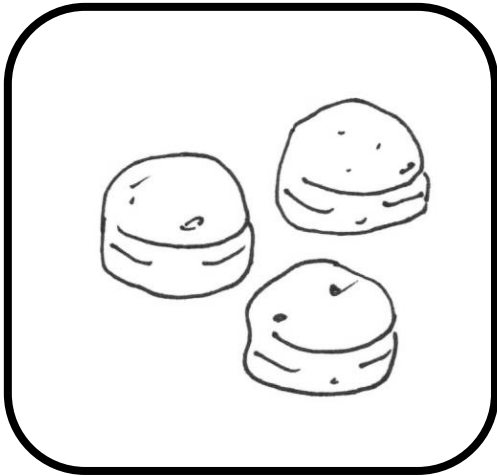

SpireGro

Om vinteren pleier vi å henge ut en meisebolle.

BOLLE

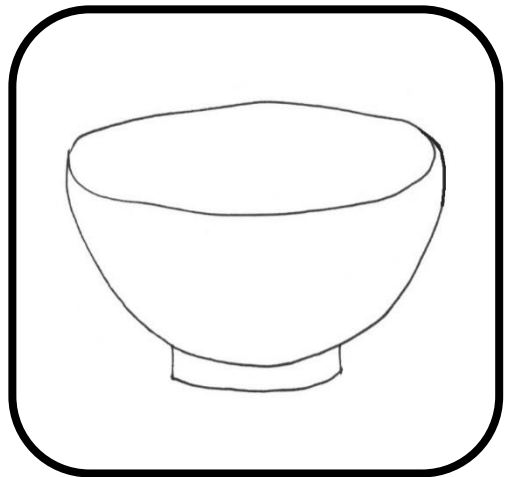
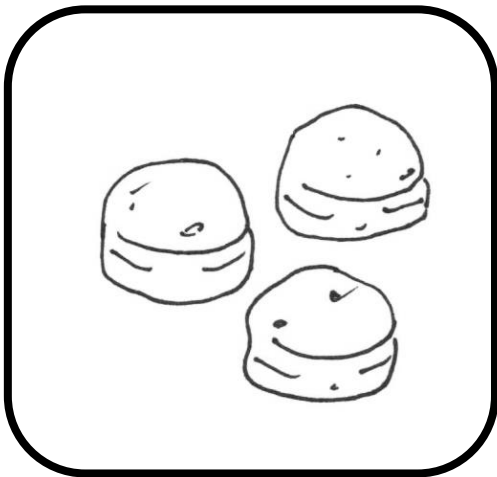

SpireGro

Det er en stor og viktig bre.

BRE



SpireGro

Jeg liker å bre over deg.

BRE



SpireGro

Vi tok et brett og forsynte oss på restauranten.

BRETT

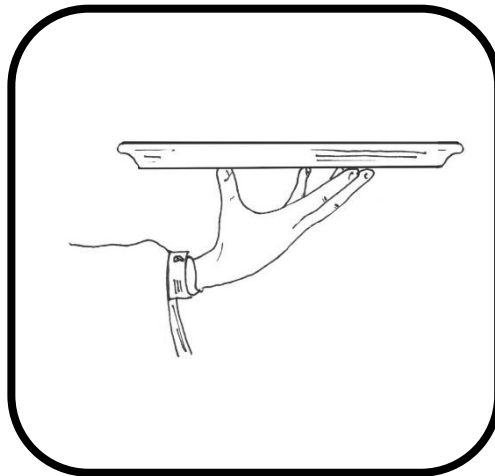
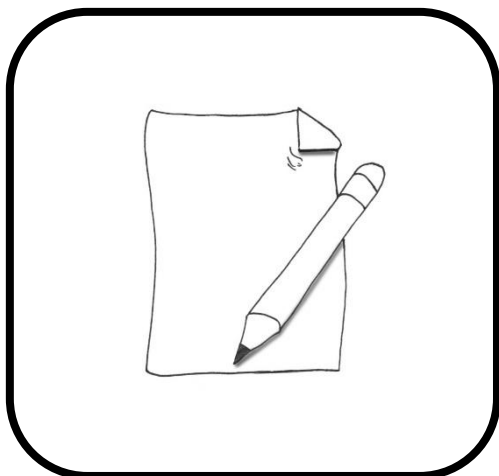

SpireGro

Jeg liker ikke å få brett på tingene mine.

BRETT

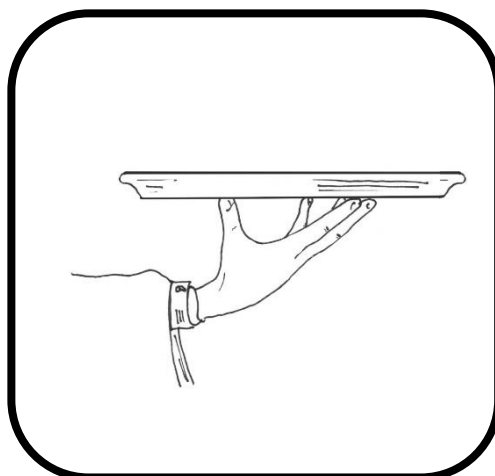
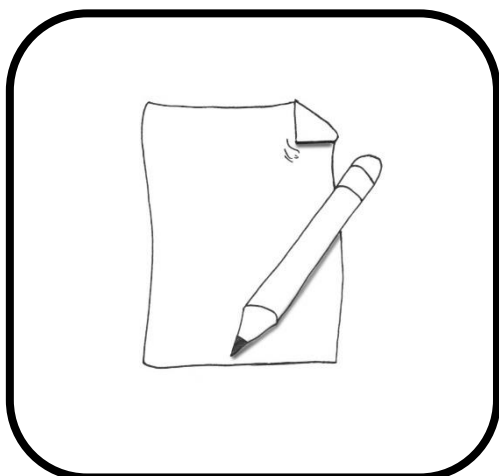

SpireGro

Det er et stort nytt og høyt bygg.

BYGG

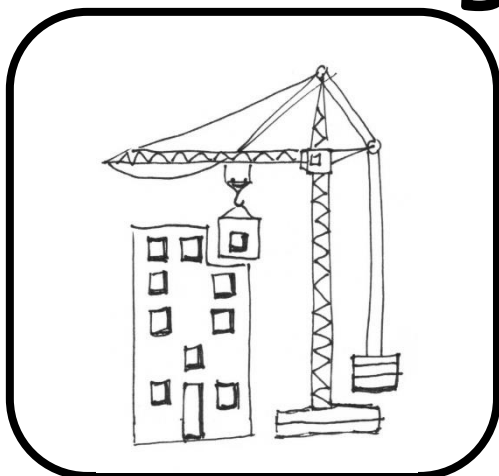

SpireGro

Jeg ser ikke forskjell på hvete og bygg.

BYGG

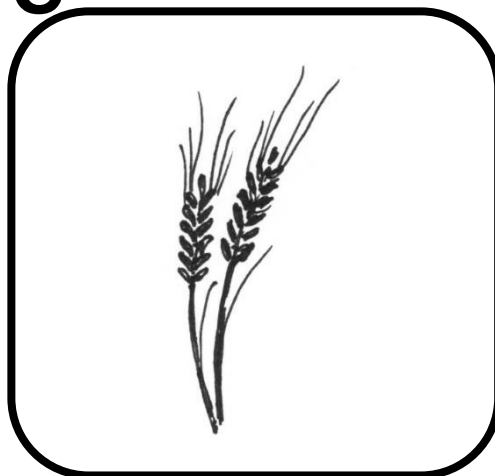
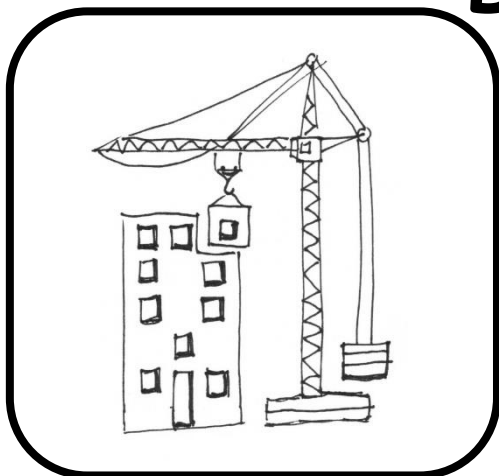

SpireGro

Vi reiste med en stor båt i påsken.

BÅT

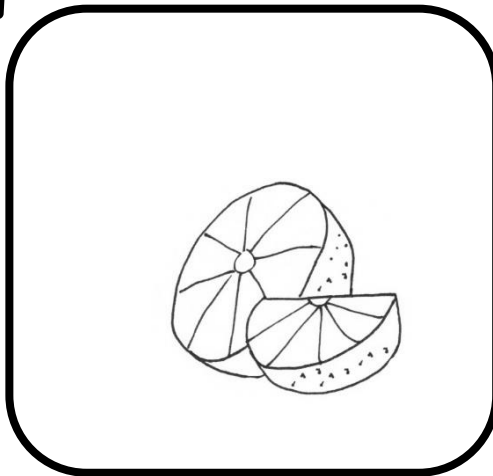
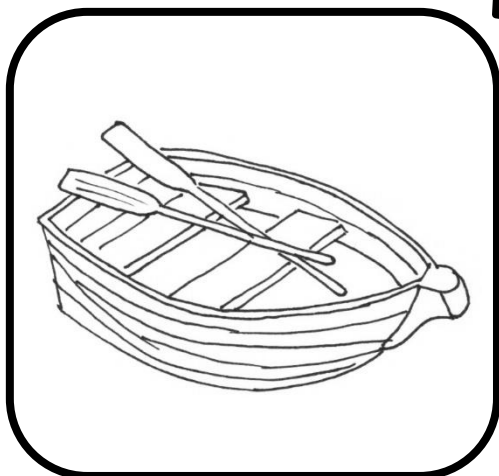

SpireGro

Tante delte i båter og ga oss litt hver.

BÅT

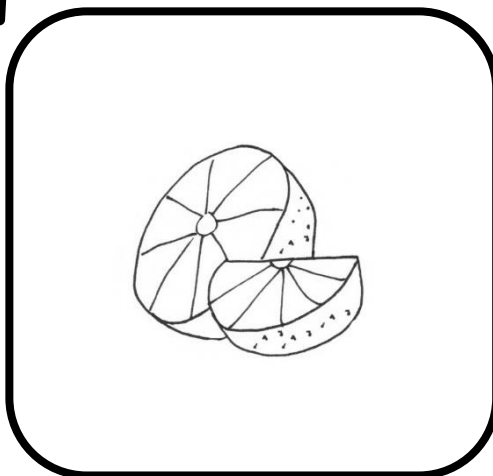
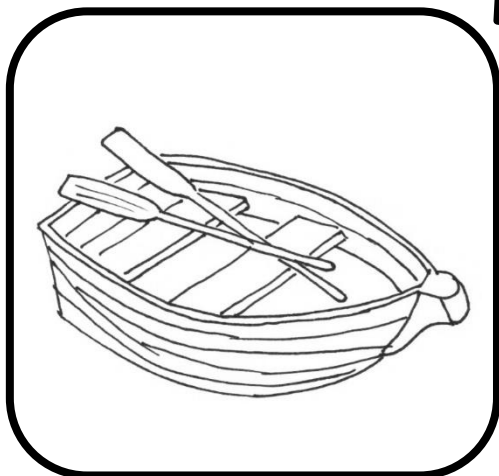

SpireGro

Mandager drar Olav rett hjem etter skolen.

DRAR



SpireGro

Tryllekunstneren drar en kanin opp av hatten.

DRAR



SpireGro

Tante Rigmor satte jakka si fast i ei dør.

DØR

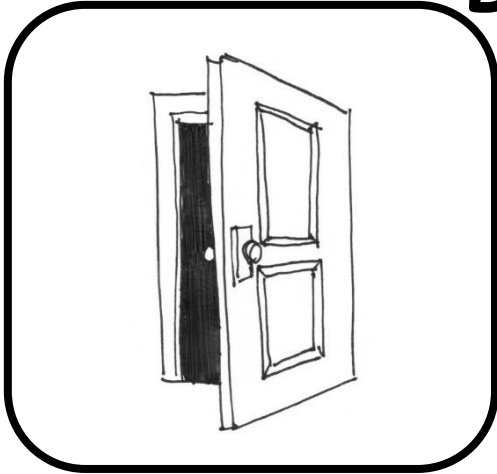

SpireGro

Meitemarker dør hvis de blir delt.

DØR



SpireGro

De fleste mennesker har egg på kjøkkenet.

EGG

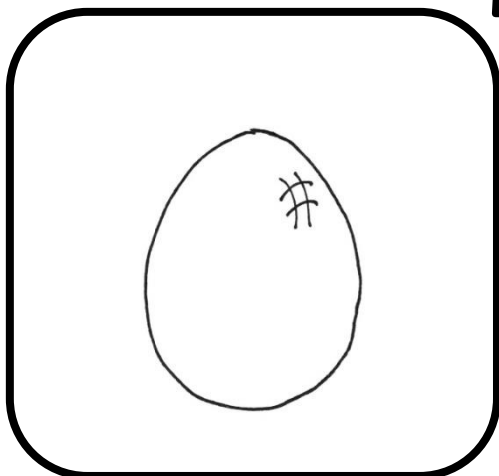

SpireGro

Det var en skarp egg.

EGG

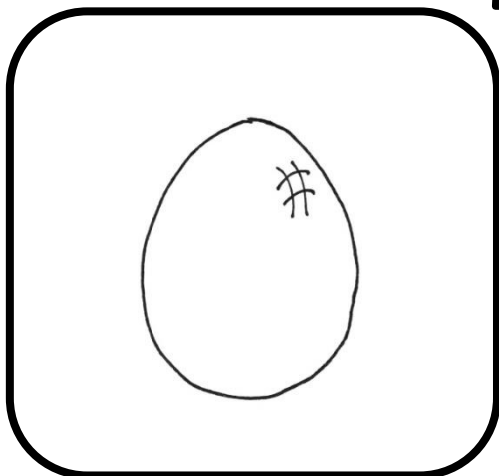

SpireGro

Du må hjelpe meg med å fire flagget.

FIRE

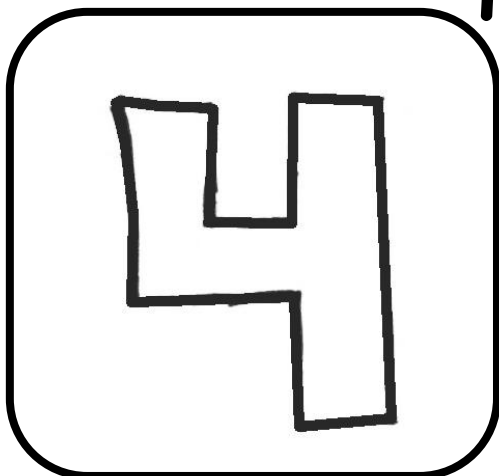

SpireGro

Det er fire måneder til 17. mai.

FIRE

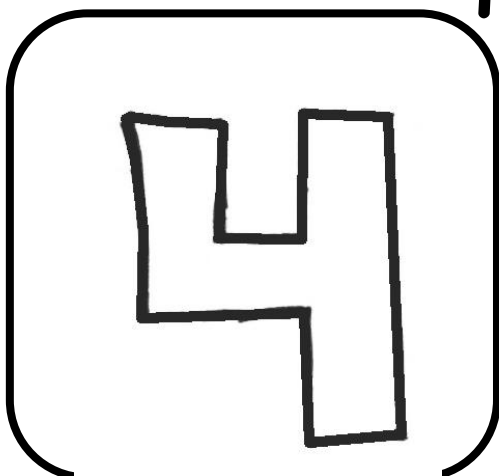

SpireGro

Kapteinen hadde glemt igjen et garn på land.

GARN

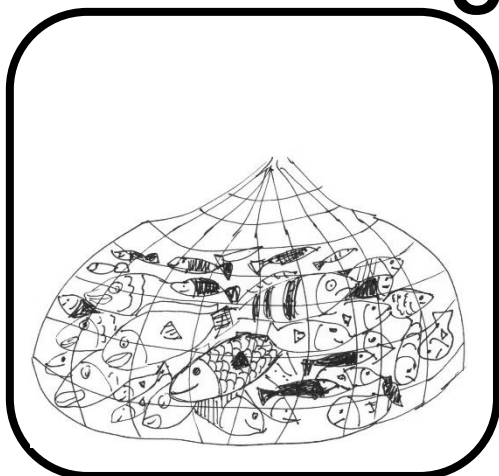

SpireGro

Katten vår elsker å leke med garn.

GARN

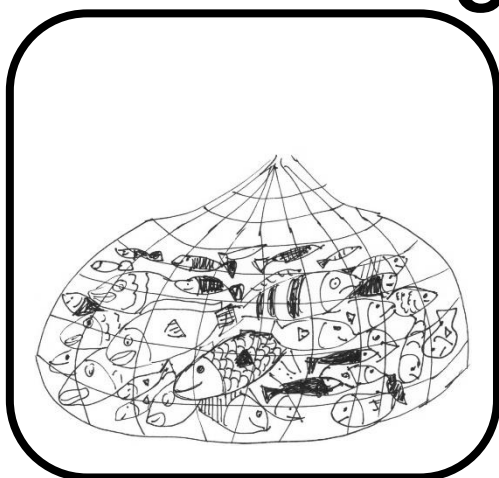

SpireGro

Mamma og pappa liker å bli gift.

GIFT



SpireGro

Bruden fikk en flaske i gave da hun ble gift.

GIFT

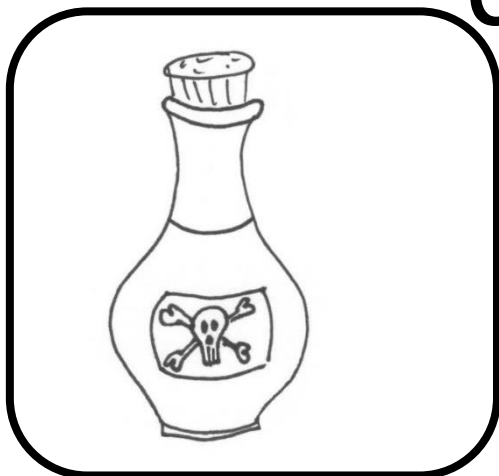

SpireGro

Gutten har premien på en hylle over vasken.

HYLLE



SpireGro

Det er viktig å hylle en stor forfatter.

HYLLE

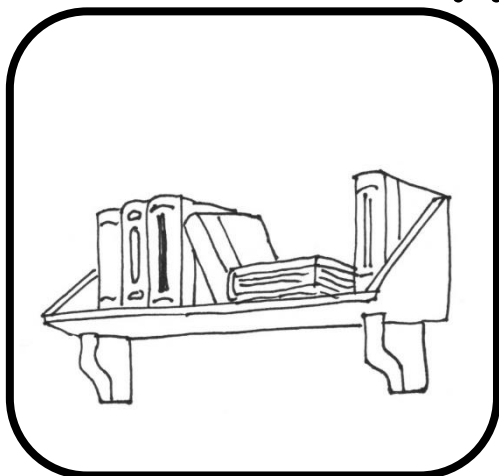

SpireGro

En jaguar koster veldig mye.

JAGUAR

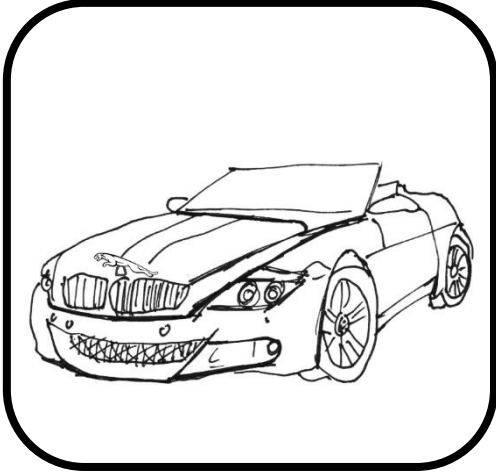

SpireGro

Jeg så en gang en jaguar løpe fort.

JAGUAR

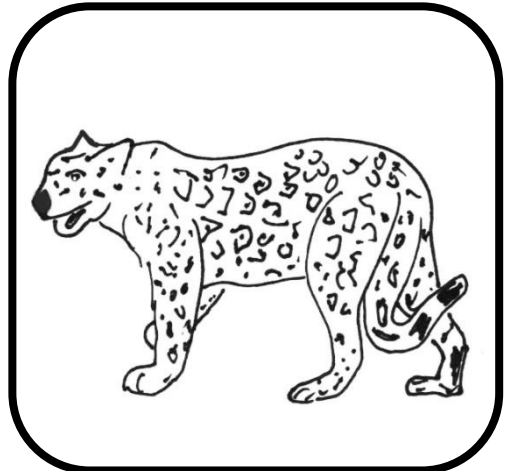
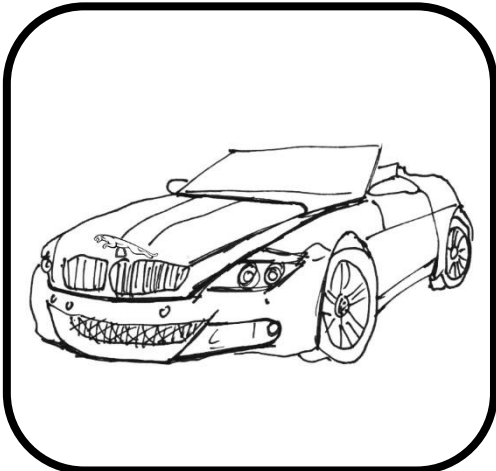

SpireGro

Anette rynket på nesa, det var et surt kart.

KART

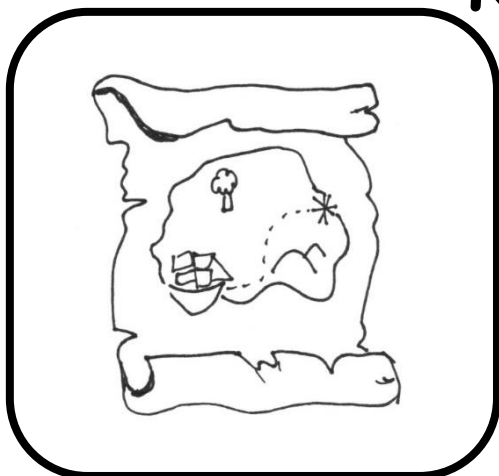

SpireGro

I treet lå et sammenrullet kart.

KART

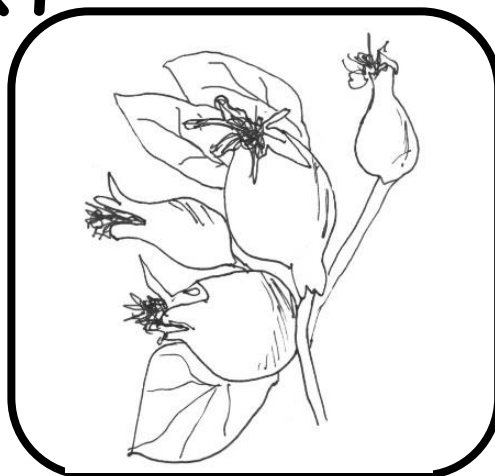
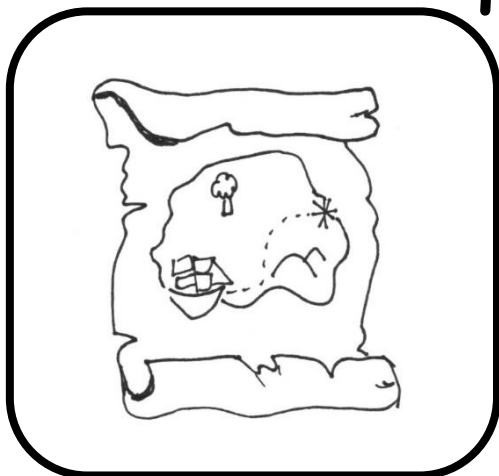

SpireGro

Jeg kan kjede meg når mamma
pynter seg.

KJEDE



SpireGro

Jeg liker ikke å bruke kjede.

KJEDE



SpireGro

Kjærester har mye kjærlighet.

KJÆRLIGHET

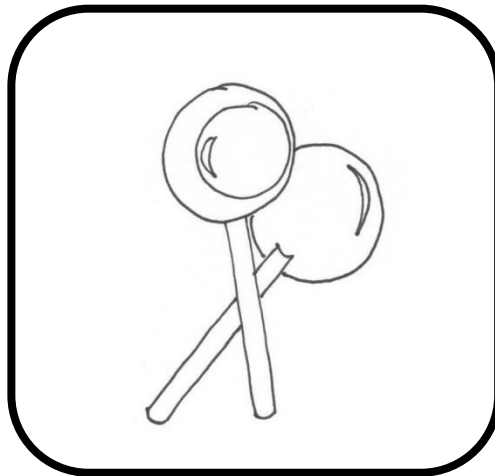

SpireGro

Jeg liker en rød kjærlighet best.

KJÆRLIGHET

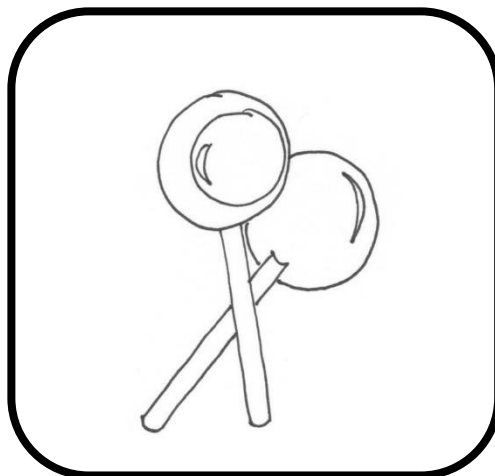

SpireGro

Vi spiller mye kort i påskeferien.

KORT

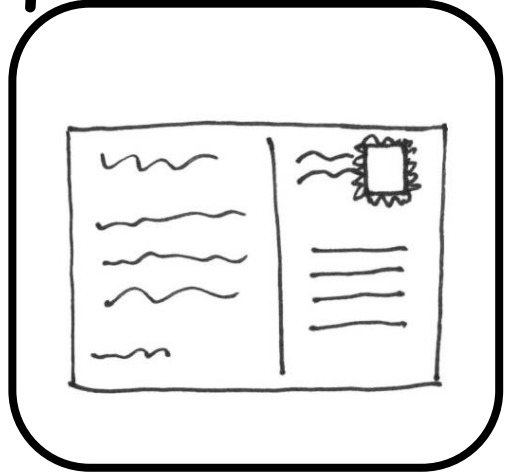
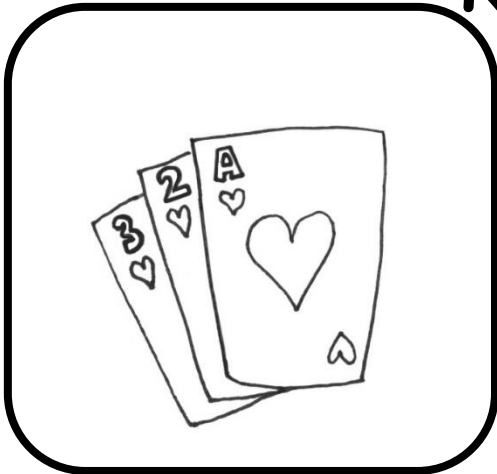

SpireGro

Du var kort når du var liten.

KORT

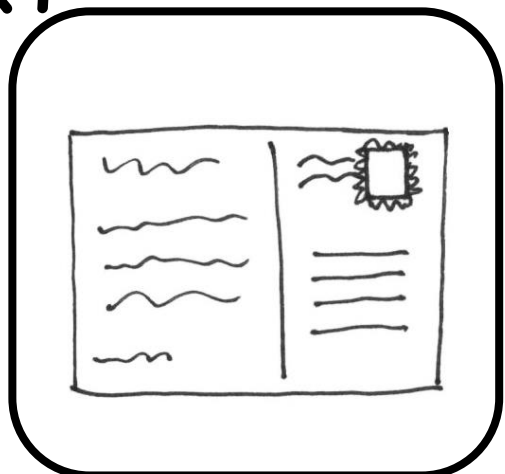
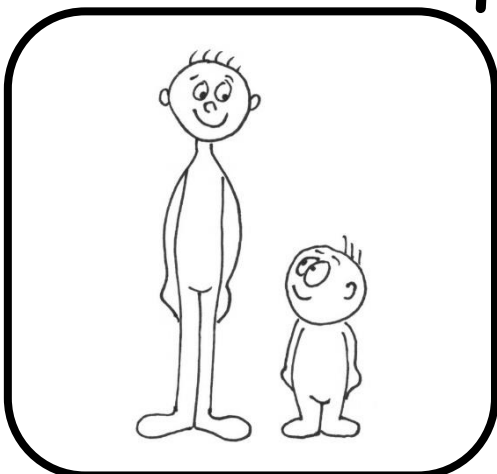

SpireGro

Kan du sende et kort til meg.

KORT

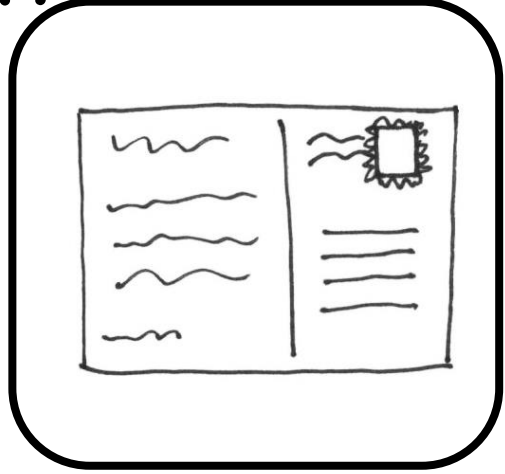
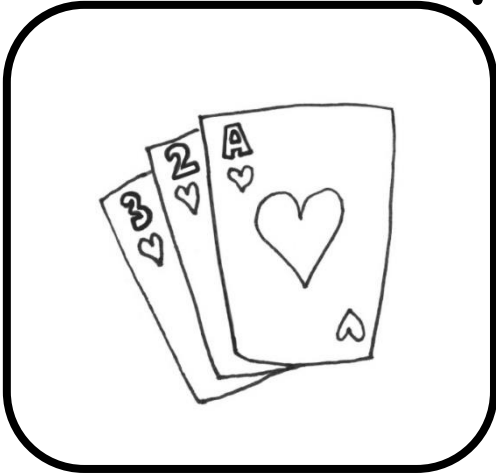

SpireGro

Det var mye røyk i luften.

RØYK

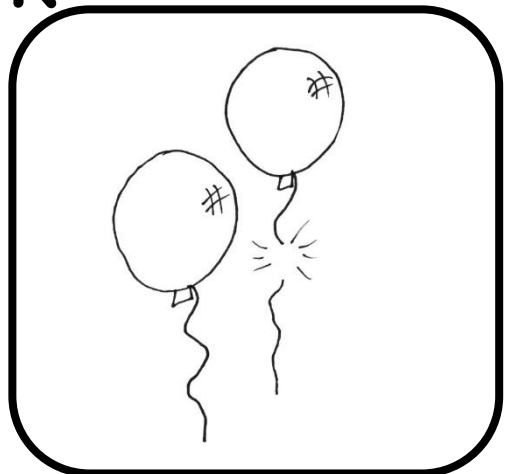
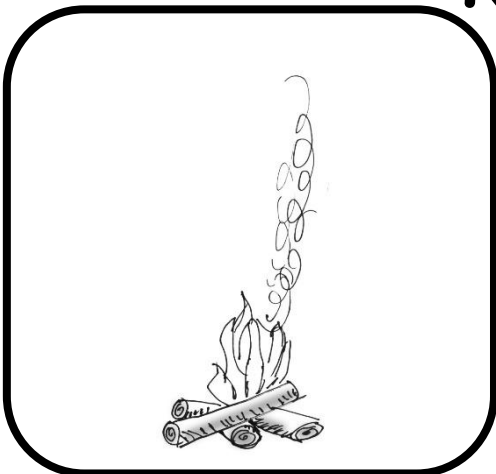

SpireGro

Snoren røyk.

RØYK

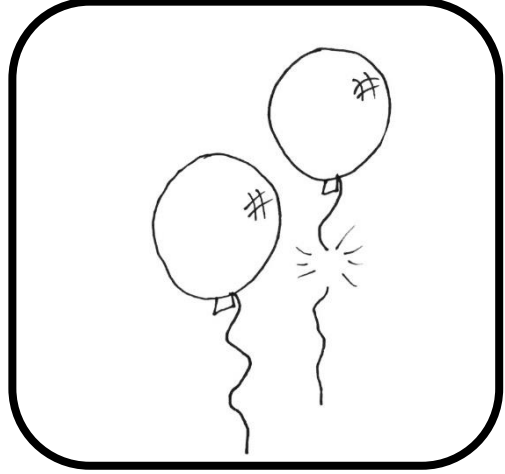
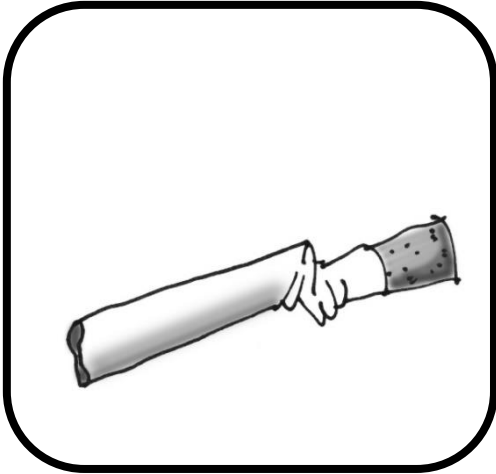

SpireGro

Det er lurt å stumpe røyken.

RØYK

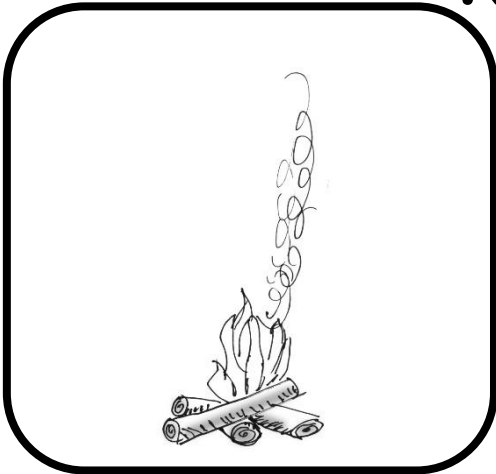

SpireGro

Babyen har lært å krabbe.

KRABBE

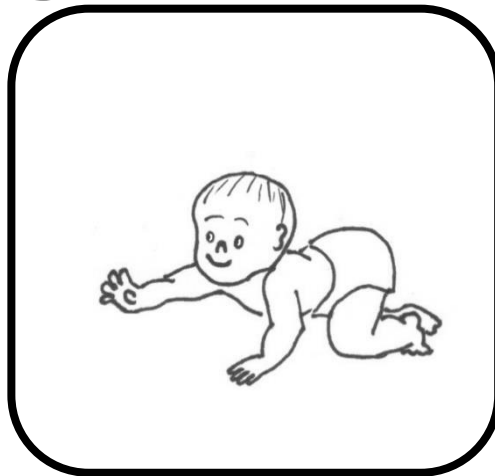
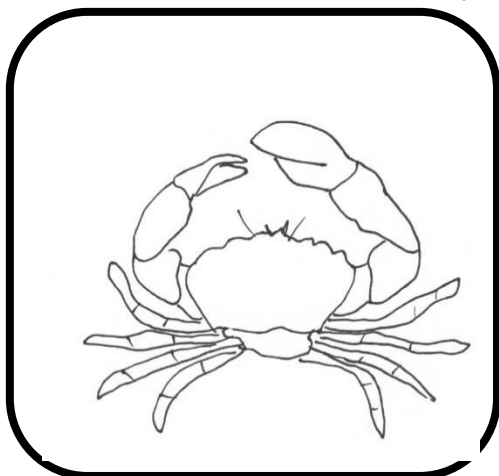

SpireGro

En krabbe har flere bein.

KRABBE

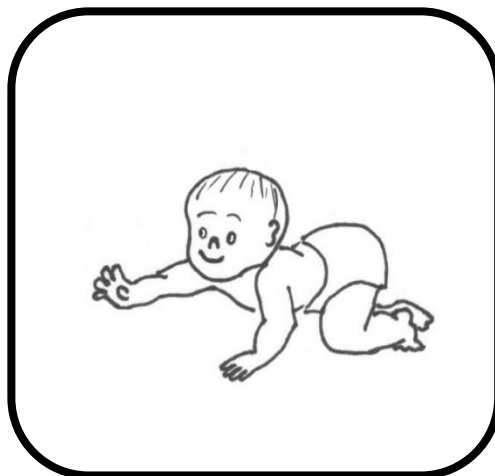
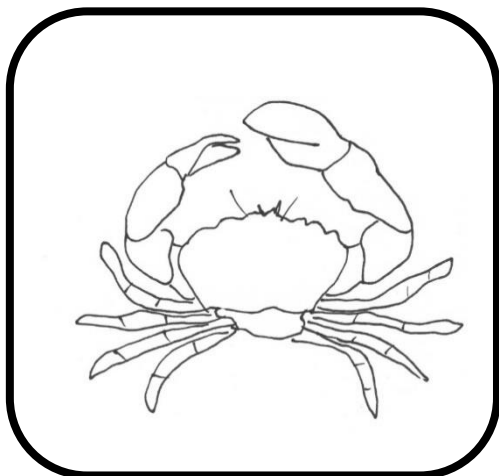

SpireGro

Isen kostet en krone.

KRONE

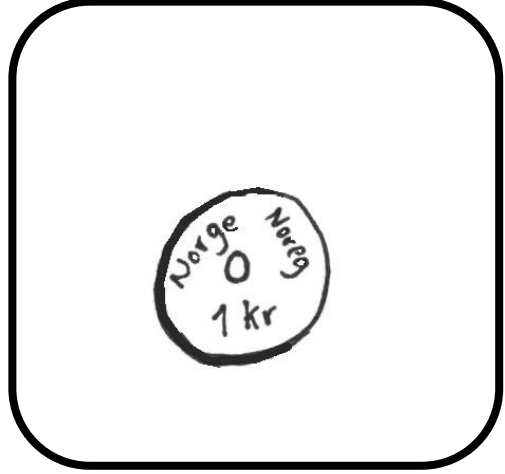
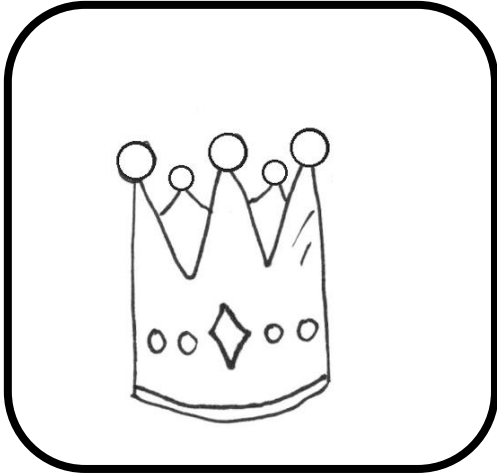

SpireGro

Kongen har en krone på hodet.

KRONE

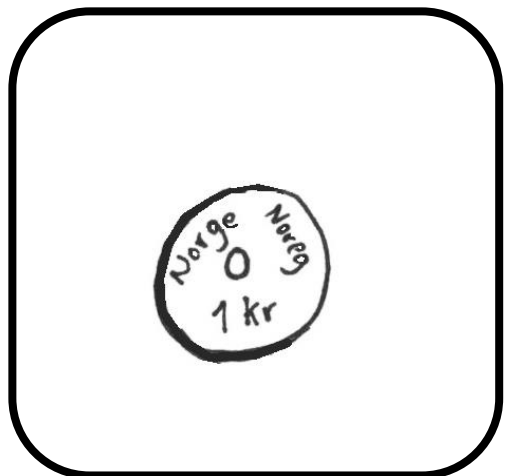
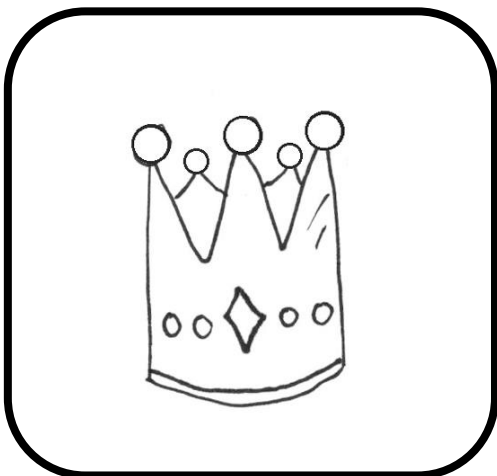

SpireGro

Den var stor og havde mange lag.

LAG



SpireGro

De spille på samme lag.

Lag



SpireGro

Kan du liste deg veldig stille?

LISTE



SpireGro

Jeg hadde med meg en liste på butikken.

LISTE



SpireGro

På skolen regner vi i matte.

MATTE

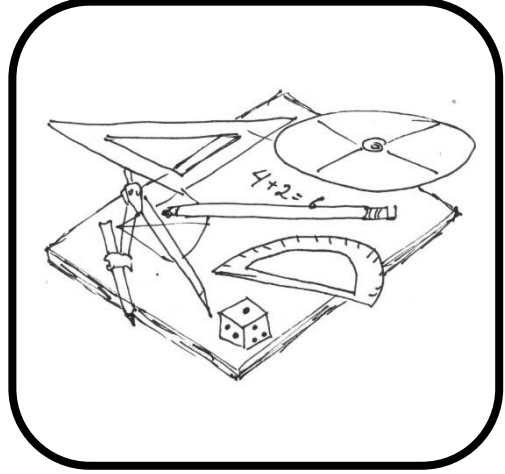
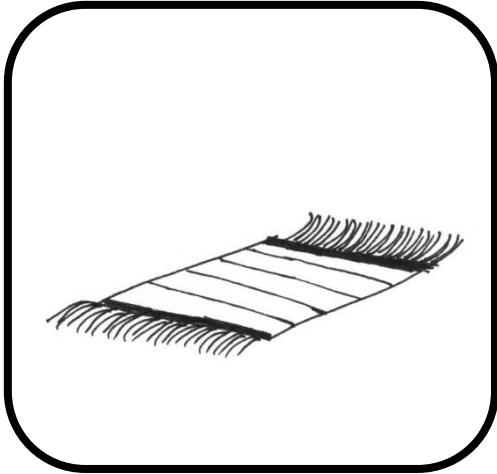

SpireGro

Jeg vil kjøpe en matte.

MATTE

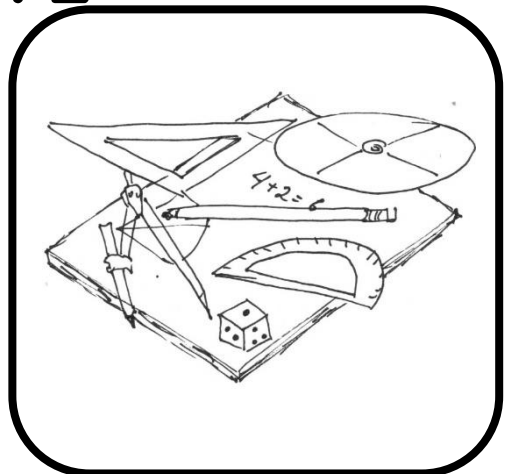
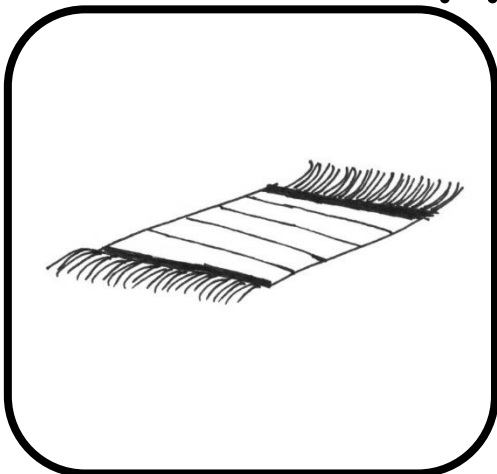

SpireGro

Det er tungt å måke snø.

MÅKE

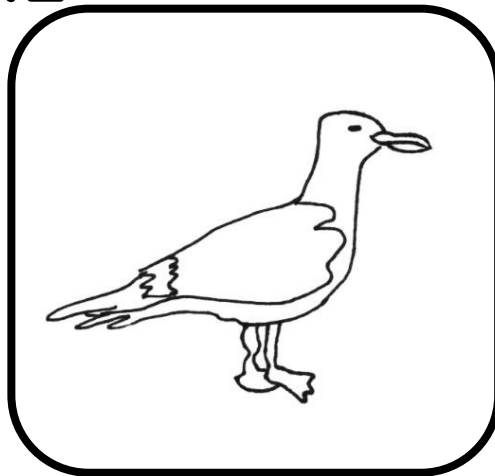
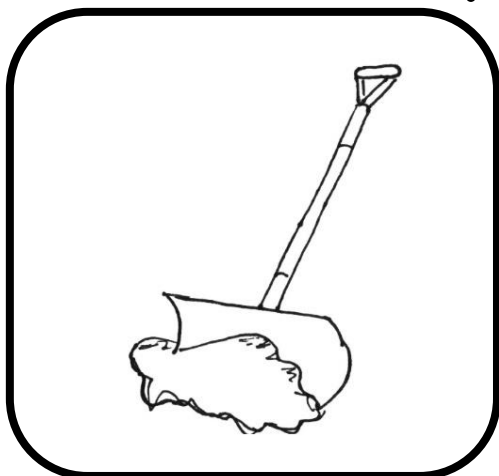

SpireGro

En måke spiser ikke snø.

MÅKE

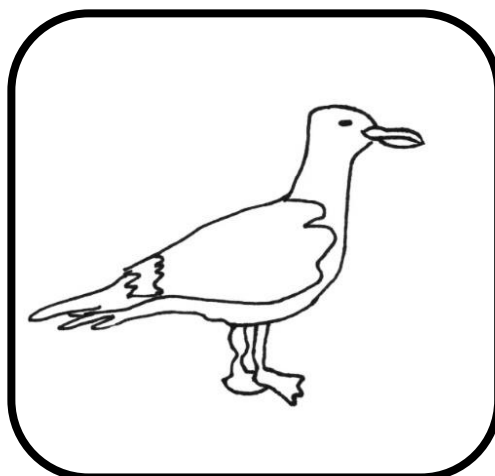
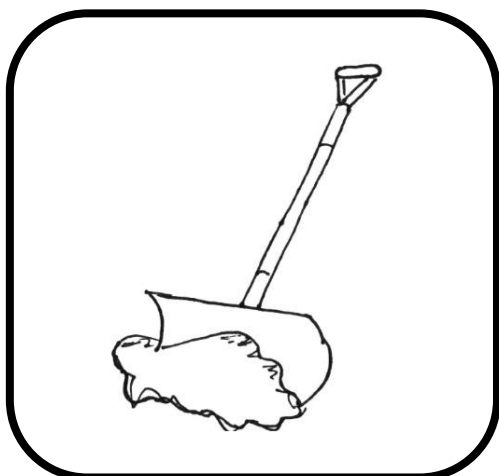

SpireGro

I dag tok vi mål av oss.

MÅL

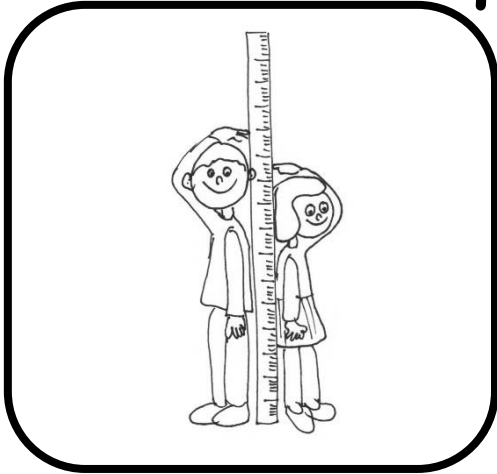

SpireGro

Det er to mål på banen.

MÅL

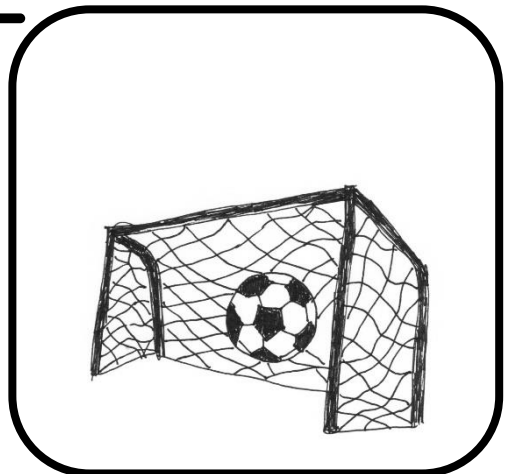
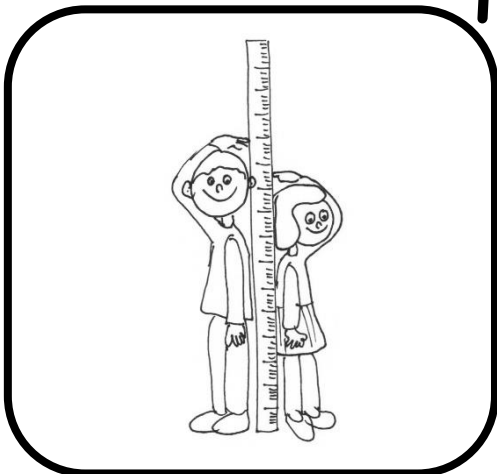

SpireGro

Han er veldig sky.

SKY

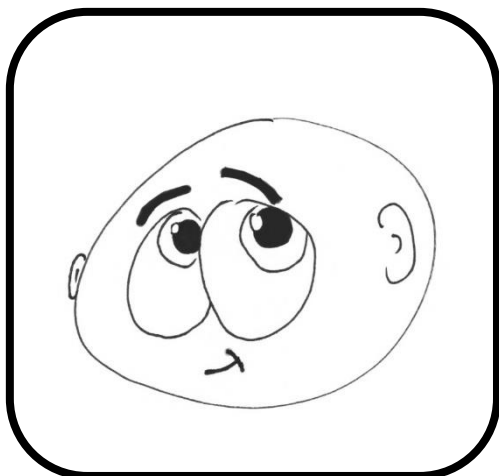

SpireGro

Det var en stor rund sky.

Sky

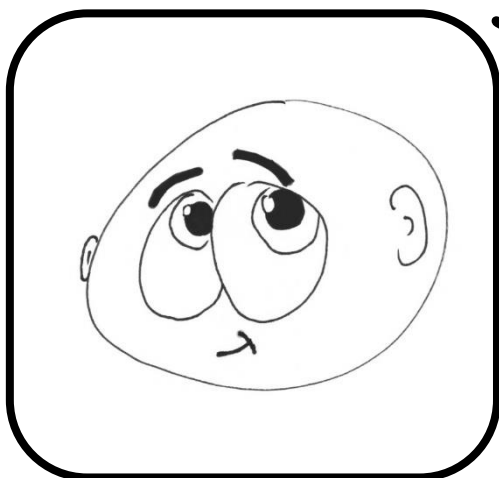

SpireGro

Det var et stort smil.

SMIL

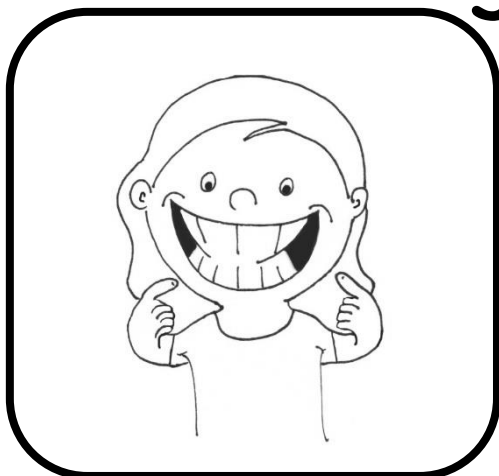

SpireGro

Hun har kjøpt en smil.

SMIL

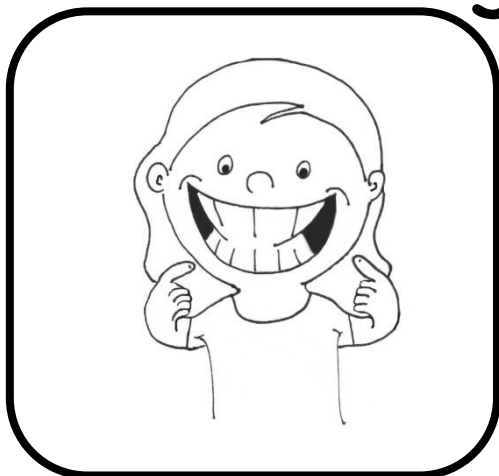

SpireGro

Han tok tak i armen hennes.

TAK

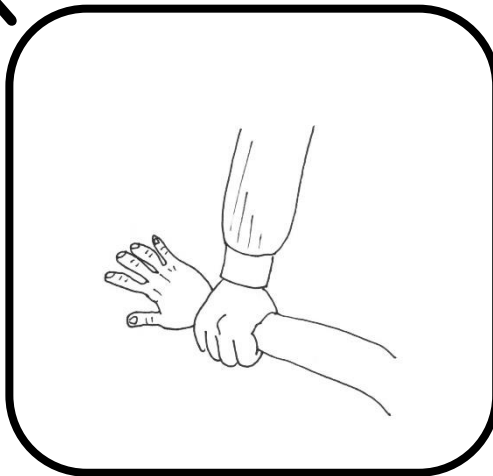
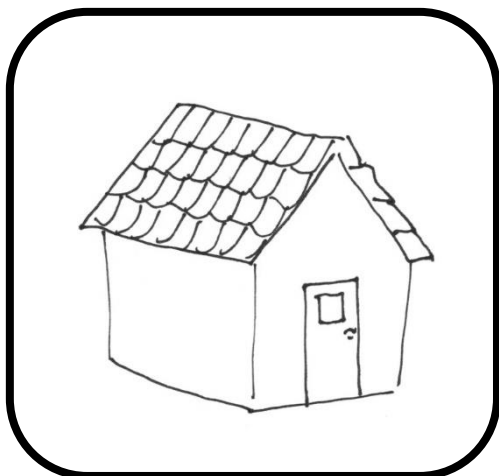

SpireGro

De har lagt nytt tak på huset.

TAK

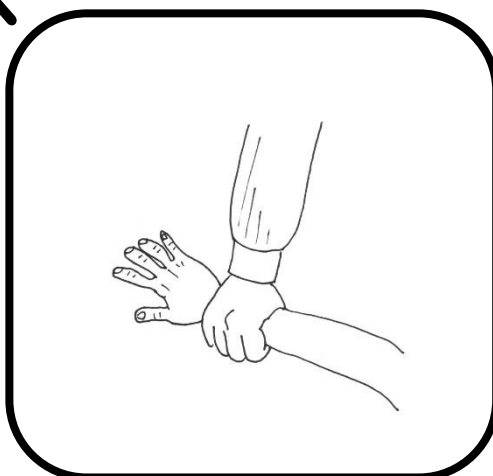

SpireGro